

GL1200-FS Waterproof Series

Electromagnetic Lock Installation Instruction

A Technical Specification

Specification	
Operating Voltage	Single Voltage: 12 or 24 VDC
	Dual Voltage: 12/24 VDC
Current Draw	Single Voltage: 0.5A/12 VDC or 0.25A/24VDC
	Dual Voltage: 0.5A/12VDC 0.25A/24VDC
Operating Temperature	-10~55°C(14~131°F)
Relay Rating	0.5A/20VDC/10W
Holding Force	1200 lbs (approx. 545 kg)
Lock Surface Temperature	≤ ambient temperature ±20°C
Lifetime Test	over 200,000 times
Weight	5.1Kg
Waterproof Rating	IPX7

B New Mounting Plate

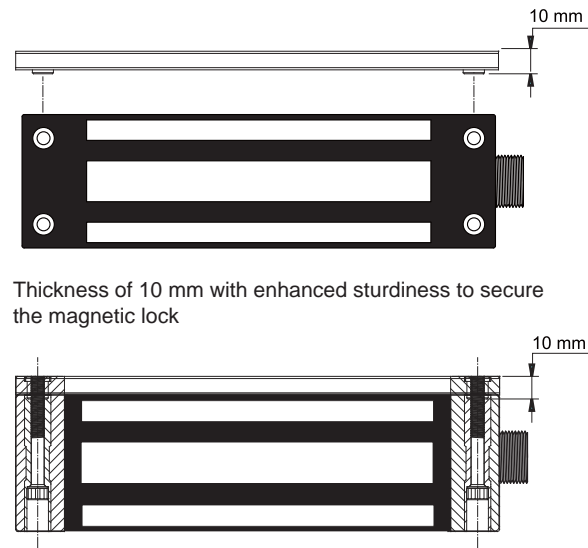

C Dimensions & Accessories

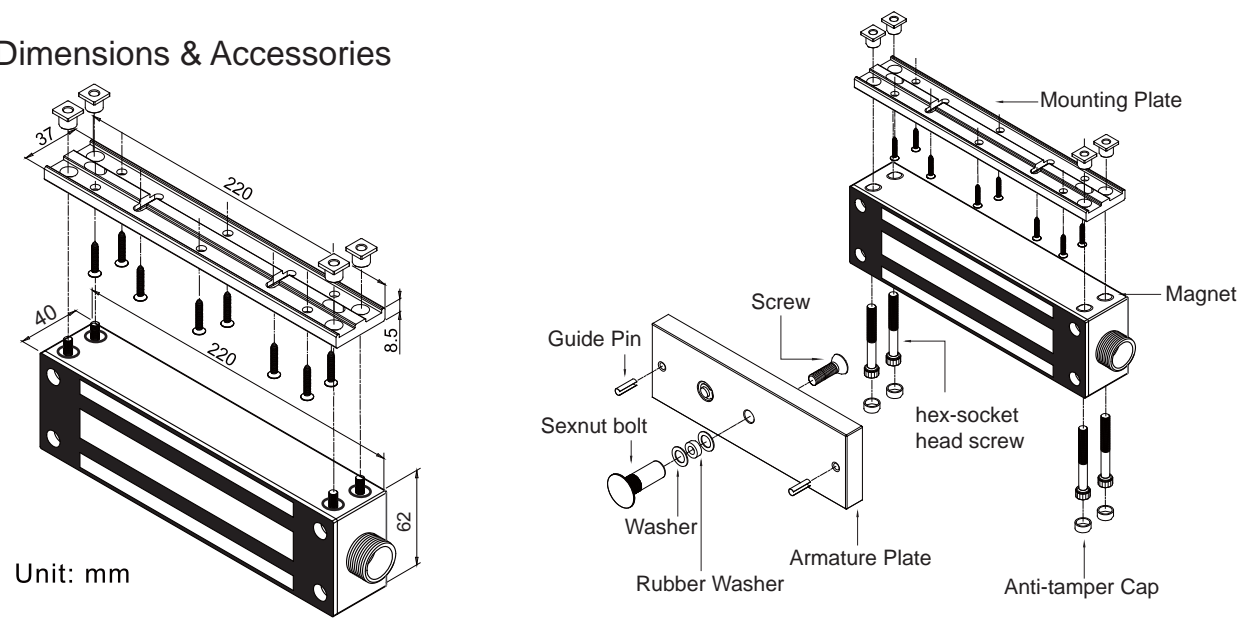

Bracket installation is based on the direction of door action and the type of door frame, e.g. narrow frame doors, frameless glass doors, inswing doors, etc.

D Installation on Right- and Left-hand Open Doors

Reverse the maglock to adapt it for the door action.

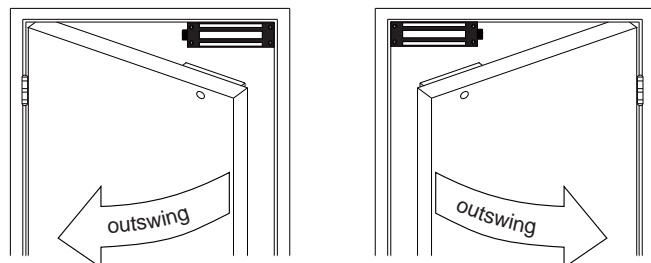

E Butt Splice (IDC) Connector

Using crimper or pliers and pressing the header of connector down to even position.

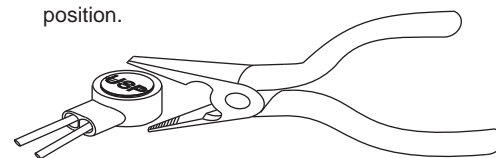

F Regular Installation

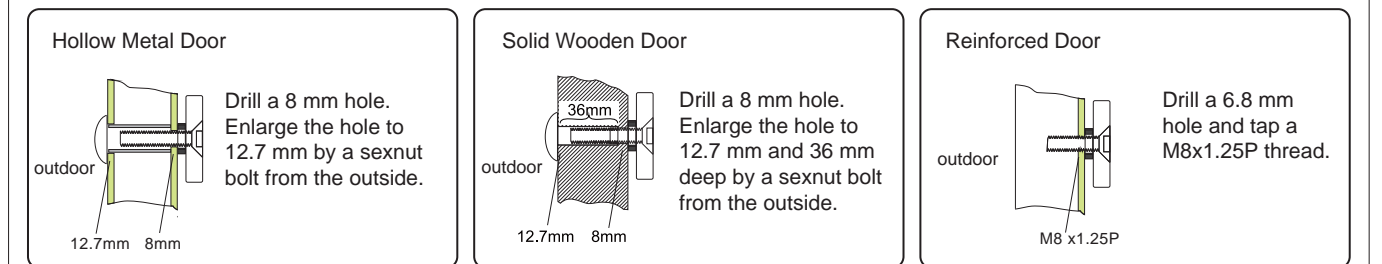
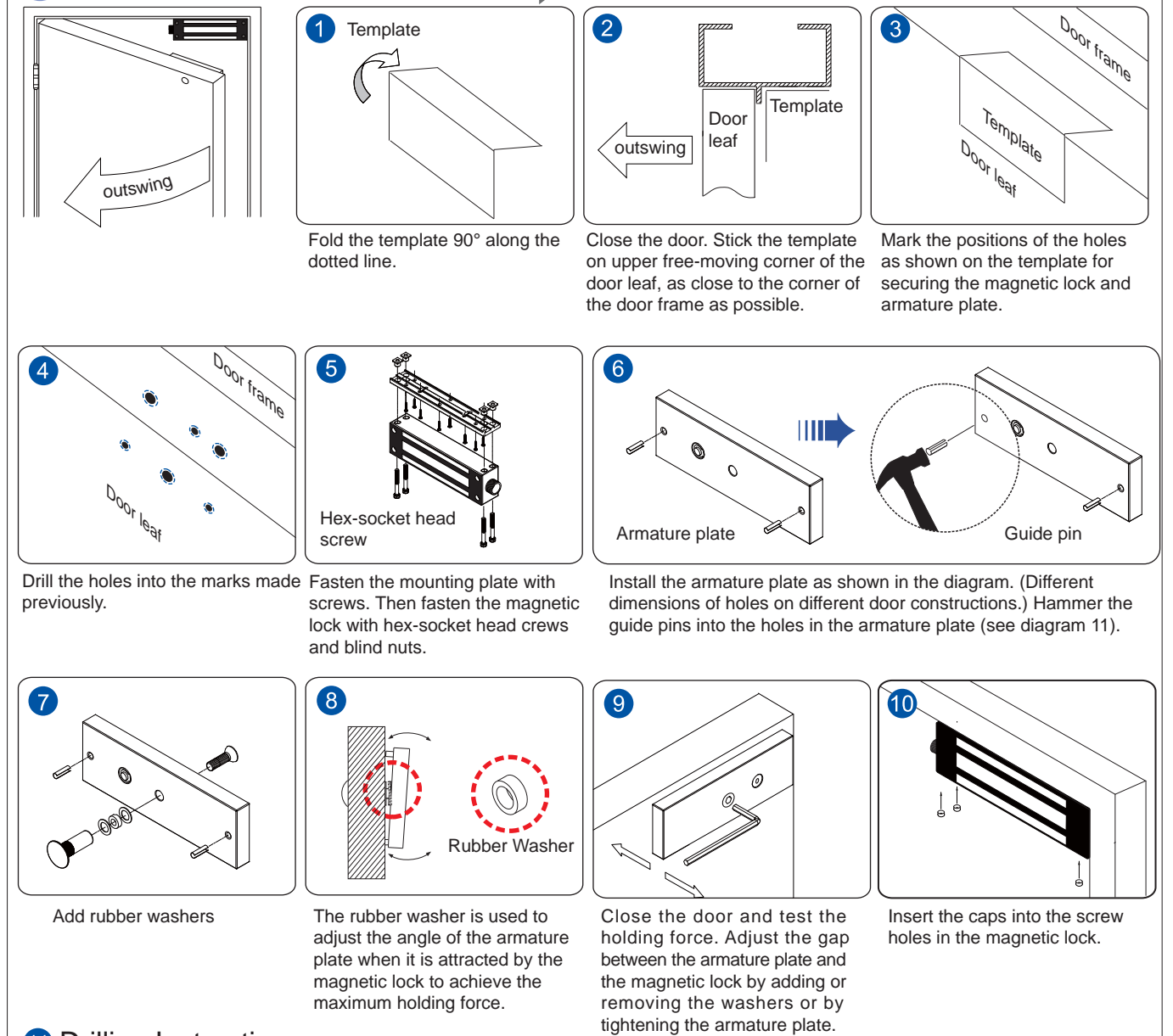

G Optional Brackets

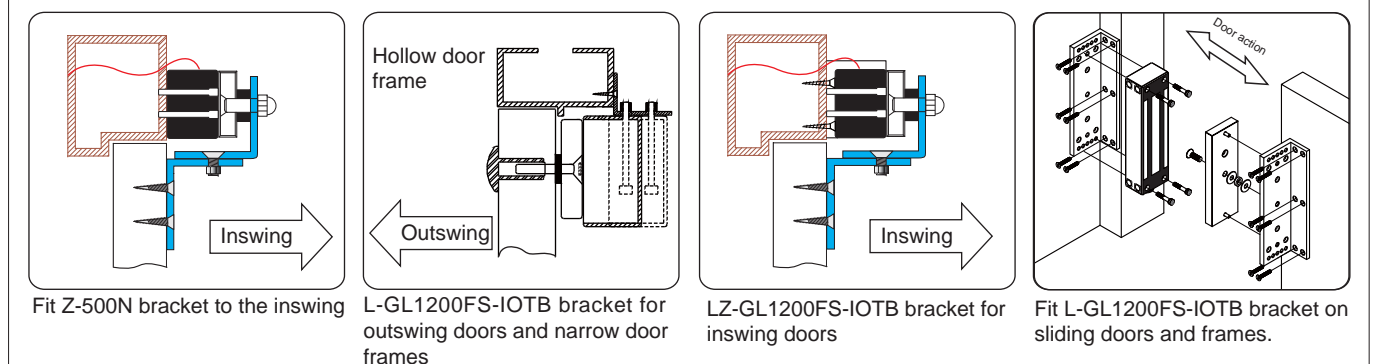

H LZ bracket for inswing doors (Surface Mount)

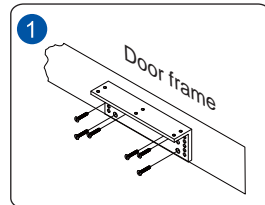

Install the L bracket to the mounting position on the door frame. Make sure the door can be freely opened.

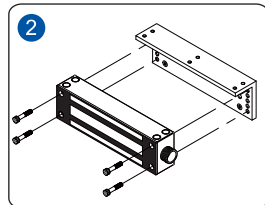

Fasten the magnetic lock to the L bracket with hex-socket head screws.

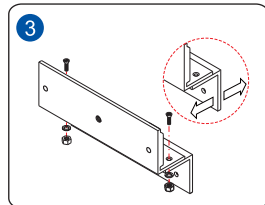

Assemble the Z bracket. Note that the bracket is movable.

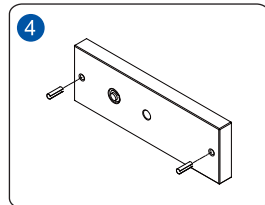

Insert the guide pins into the armature plate.

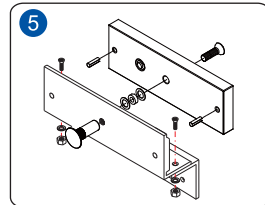

Fasten armature plate to Z bracket. The rubber washer must be placed between the armature plate and the bracket.

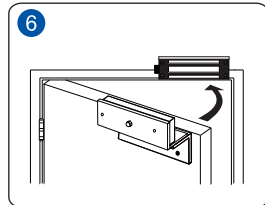

Close the door and connect to the power.

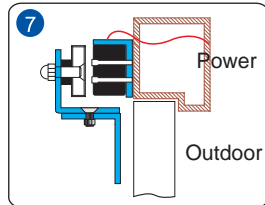

After the armature plate and the magnetic lock stick to each other, adjust the Z bracket to fit the door frame.

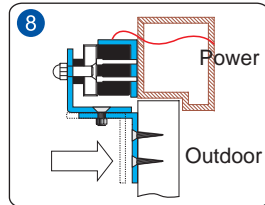

Adjust and fasten the Z bracket. Close the door and test the holding force. Adjust the gap between the armature plate and the magnetic lock by adding or removing the washers or by tightening the armature plate.

I Z bracket for inswing doors (Face Mount)

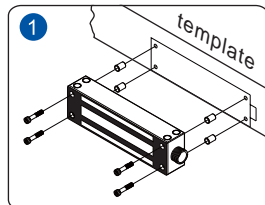

Drill holes as shown on template and fit blind nuts into holes. Fit maglocks with hex-socket head screws.

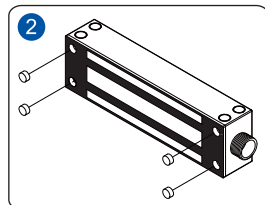

Insert caps into screw holes in maglock.

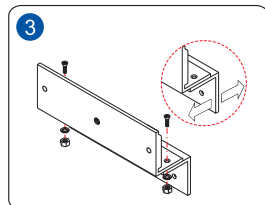

Assemble Z bracket. Note that the bracket is movable.

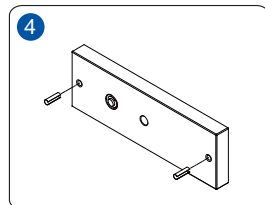

Insert guide pins into armature plate (to fix it).

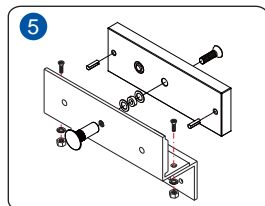

Fasten armature plate to Z bracket. Add plastic washers between bracket and armature plate.

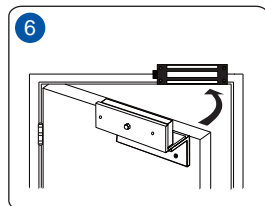

Close door and connect to the power.

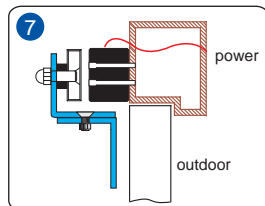

After maglock attracts armature plate, fit Z bracket to door leaf.

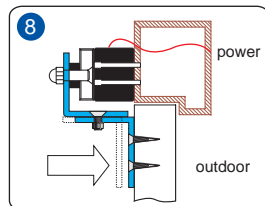

Adjust and fasten upper part of Z bracket. Close door and test holding force. Adjust the gap between armature plate and maglocks by adding or removing washers or tightening the armature plate.

J Note:

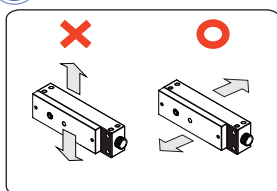

The magnetic lock must face-to-face align with the armature plate or the holding force will decrease by 25%.

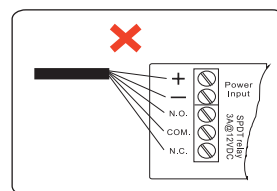

Do not apply power wires and signal wires in the same cable or conduit.

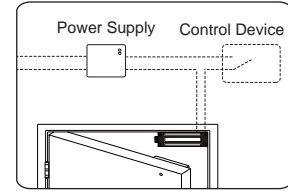

The magnetic lock is fail-safe. It requires a UPS to supply power to keep the door locked during power failure.

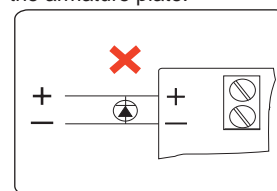

Remove any diode and varistor to prevent the door from delayed opening.

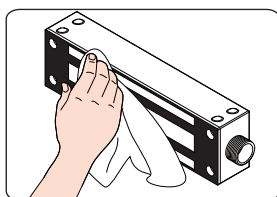

Regularly wipe the surface of the magnetic lock with anti-rust oil.

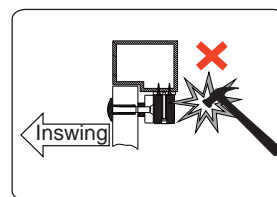

The magnetic lock and wires must not be exposed. Install LZ bracket for inswing doors.

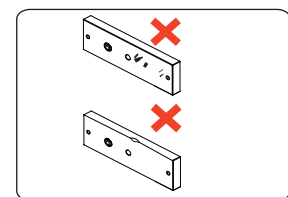

Make sure the faces of the magnetic lock and the armature plate are clean, intact and no rust.

K Connecting Diagram with 2 m cables

Model	Wire Leads (Power input is polarity free)	Power Input	Bond sensor output	Diagram
GL1200-FS-IOTB-12 GL1200-FS-IOTB-24	2 Wire Leads	12VDC or 24VDC	—	
GL1200M-FS-IOTB-12 GL1200M-FS-IOTB-24	5 Wire Leads		✓	
GL1200-FS-IOTB	4 Wire Leads	12VDC / 24VDC	—	
GL1200R-FS-IOTB	6 Wire Leads		✓	
GL1200M-FS-IOTB	7 Wire Leads		✓	

L Trouble Shooting

Problem	Possible Cause	Solution
Door does not lock	No power	<ol style="list-style-type: none"> 1. Make sure the wires are properly connected. 2. Make sure the power supply unit works well. 3. Make sure the relay is connected to the N.C. contact.
Low holding force	Poor contact between electromagnet and armature plate	<ol style="list-style-type: none"> 1. See if the armature plate is deformed. 2. Make sure to insert the rubber washer between the armature plate and the bracket. 3. See if the surfaces of the armature plate and the magnetic lock are clean.
	Low voltage or incorrect voltage setting	<ol style="list-style-type: none"> 1. Check if the voltage selection is correct. 2. Check the power voltage at the terminals.
Sensor output is not functioning	A secondary diode was installed across the electromagnet lock	Remove any diode installed across the magnetic lock.
	Misalignment between the armature plate and electromagnet lock	Make sure the armature plate and the magnetic lock are aligned face-to-face.